

RAINWATER

An effective rainwater management system is an important part of every building. Our extensive range of fascia and gutter systems have a profile to aesthetically compliment every roof.

AUTHORISED SUPPLIER



Freeman Roofing

Brockelsby Roofing

Roofline Marlborough

Canterbury Long Run Roofing Ashburton

Canterbury Long Run Roofing Timaru

Roofing Solutions

Wanaka Roofing

Queenstown Roofing



Part of the Freeman Group

Wanaka | 03 443 1250

wrs@roofing.co.nz

www.roofing.co.nz

Our rainwater systems include a selection of guttering and spouting products for residential and commercial applications, as well as attractive downpipe and fascia solutions.



CUSTOM / COMMERCIAL BOX

Custom made box gutter can be made to any size you need for commercial purposes. A swage down the length of the gutter for strength and aesthetic purposes can also be added to suit your needs.

Internal and external mounting brackets are available.

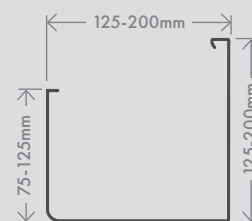
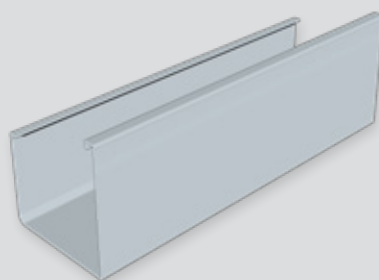

ALPINE QUAD

Quad gutter provides an attractive take on the traditional quarter round gutter, providing a bigger water flow capacity for higher rainfall areas. Quad's gently curved front and strong swaging offer a unique blend of traditional & modern looks.

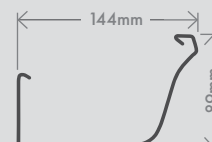
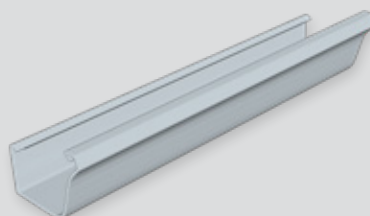

ALPINE FASCIA

Fascia is used as a base to attach the roof guttering on to, or as a cover to hide the fixing space between the roof, eaves and wall. More than just functional, Fascia is designed to form a neat, attractive edge between the roofing and wall surface, as well as preventing birds and rodents from gaining entry to your roof cavity.

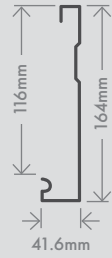
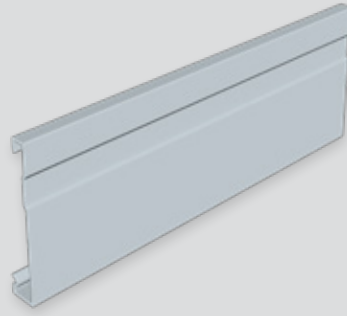

DOWNPIPE

We have a wide range of rectangle profile or round profile Colorsteel™ downpipe to suit the colour and style of your roof. We also supply a complete range of downpipe elbows, T-junctions and mounting brackets. Available in 65mm, 80mm and 100mm.

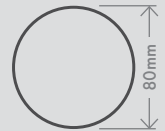
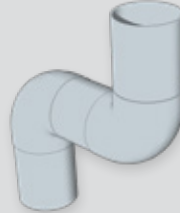

CHIMNEY CAP

Chimney caps with or without a flu can be manufactured to meet customers' needs.

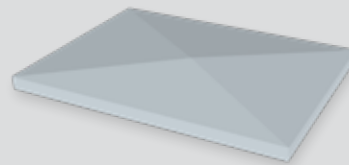

SIDE DETAIL



WITHOUT FLU



WITH FLU

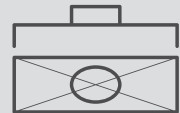

RAINWATER HEAD

Custom rainwater heads can be manufactured to meet customers' needs. Available in Colorsteel, Zinalume and copper.

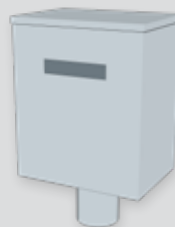

BOX

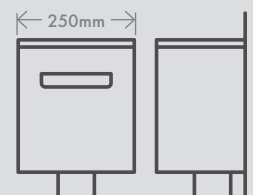

TAPERED

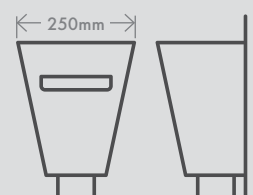

We use genuine COLORSTEEL® from steel produced in New Zealand



Labour Efficient

Quick to install, snap-on gutter brackets allow easy adjustment of gutter fall.



Long Run

Custom manufactured to length, avoiding the need for joins in most applications.



Pitch

Suitable for pitch roofs with flat soffits and roofs of up to 30° pitch with sloping soffits.



Colour Choice

A wide range of standard colours is available with additional colours and coatings available on request.

GUTTER ACCESSORIES

We also stock internal and external gutter brackets, as well as gutter stop ends and external gutter corners.

MATERIALS & DURABILITY

Available in:

Thickness (BMT)

Colorsteel®	.55mm G300
Zincalume®	.55mm G300
Galvsteel™	.55mm G300

Gutters also available in copper and aluminium and other non-ferrous metals.

Various types of coatings are available to suit all environments including industrial and coastal conditions.

For optimum performance, the severity of the environment in which the cladding will be installed should determine both the metal and type of coating to be used.

WARRANTY

Gutters & Fascias covered by warranty for:

- Coating performance
- Corrosion resistance
- Substrate integrity

Warranty is subject to the use of the appropriate product for the environment. A written warranty is available on request.

MAINTENANCE

To Prevent the accumulation of dirt or other material not removed by rain, manual washing is required.

Recommended washing frequency based on environment:

	Environmental conditions	
	Severe	Moderate
Sheltered Areas*	Every 3 months	Every 6 months

*Areas that do not receive adequate rain washing e.g. underside of gutters and fascias.

All gutters must be kept clean of debris.

Minor white corrosion, which may appear on the underside of fascia and gutters, is a natural weathering phenomenon of pre-painted steel and does not constitute a failure of the coating system.



Providing quality roofing products and services across eight convenient locations

To find your nearest branch visit www.roofing.co.nz